

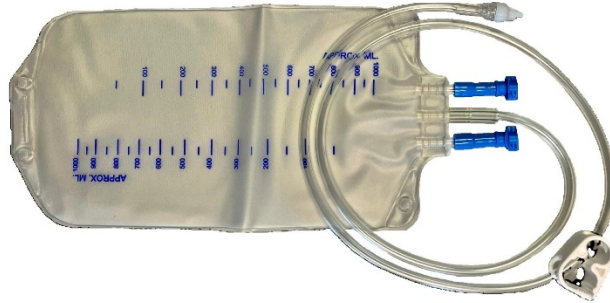

P3500 – TRANSFER BAG 1,000 ML

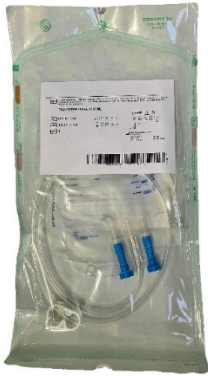
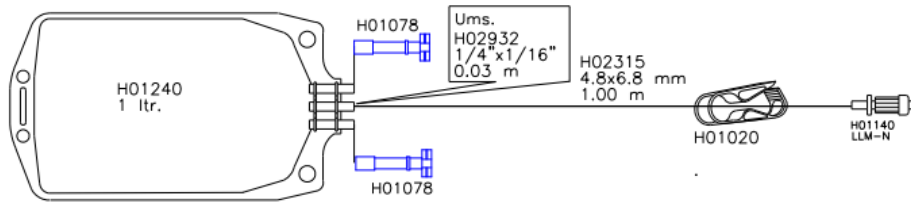

Specifications:

bag volume:	1,000 ml
bag material:	PVC (contains DEHP)
tubing length	1.00 m
connection:	LuerLock Male
packaging:	sterile, single
packaging unit:	10 pcs

P3501 - SPARE LINE 1/4X1/16 PVC 1.50 M

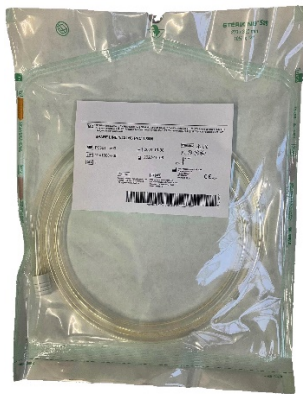
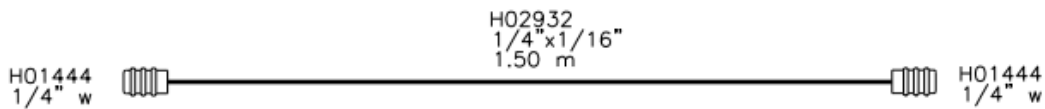

Specifications:

tubing; length:	PVC 1/4" x 1/16" (inside diameter x wall thickness); 1.50 m
shore hardness (Shore A):	67
packaging:	sterile, single
packaging unit:	10 pcs

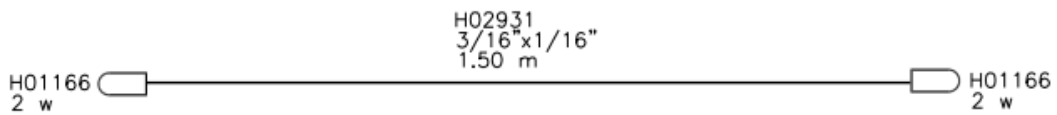
**P3502 - SPARE LINE 3/16x1/16 PVC 1.50 M****Specifications:**

tubing; length:	PVC 3/16" x 1/16" (inside diameter x wall thickness); 1.50 m
Shore hardness (Shore A):	67
packaging:	sterile, single
packaging unit:	10 pcs

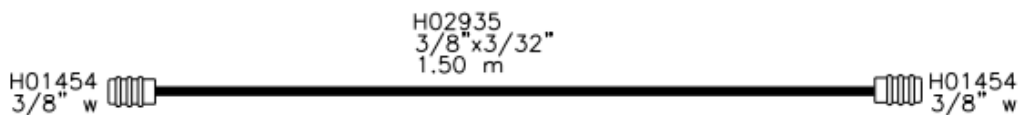
P3503 - SPARE LINE 3/8X3/32 PVC 1.50 M**Specifications:**

tubing; length:	PVC 3/8" x 3/32" (inside diameter x wall thickness); 1.50 m
Shore hardness (Shore A):	67
packaging:	sterile, single
packaging unit:	5 pcs

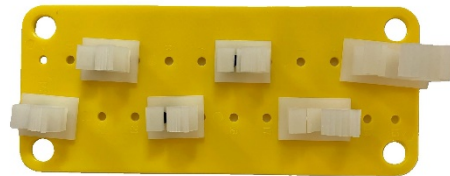
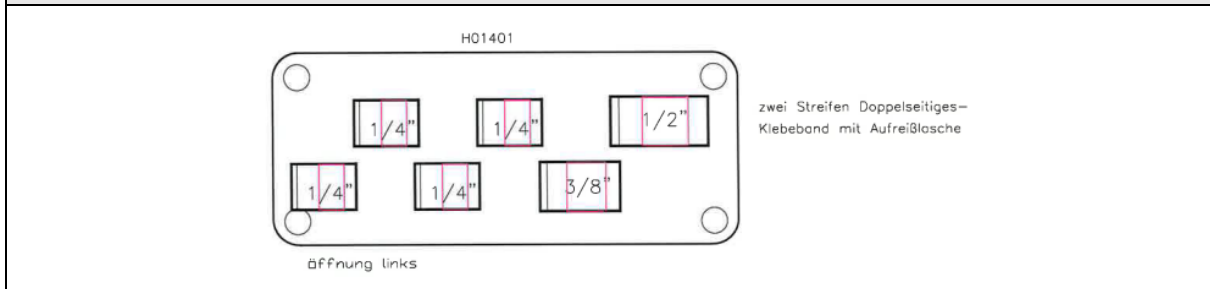
P3504 – TUBING HOLDER 1/4" x 1/4" x 1/4" x 1/4" x 3/8" x 1/2"

Specifications:

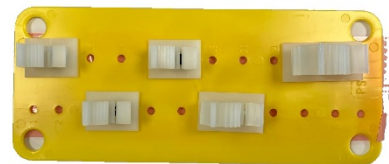
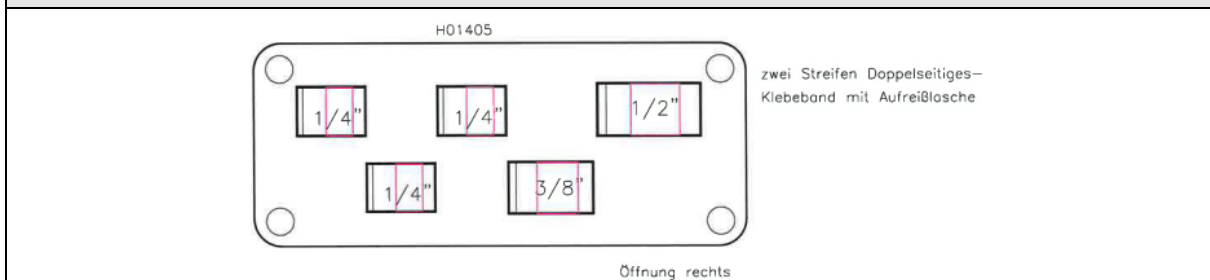
dimensions:	1/4" x 1/4" x 1/4" x 1/4" x 3/8" x 1/2"
clip opening:	left
packaging:	sterile, single
packaging unit:	25 pcs

P3505 – TUBING HOLDER 1/4" x 1/4" x 1/4" x 3/8" x 1/2"

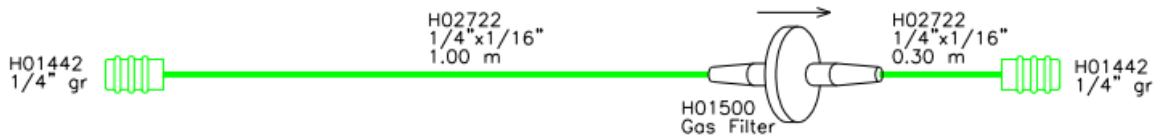
Specifications:

dimensions:	1/4" x 1/4" x 1/4" x 3/8" x 1/2"
clip opening:	right
packaging:	sterile, single
packaging unit:	25 pcs

**P3506 – GAS LINE****Specifications:**

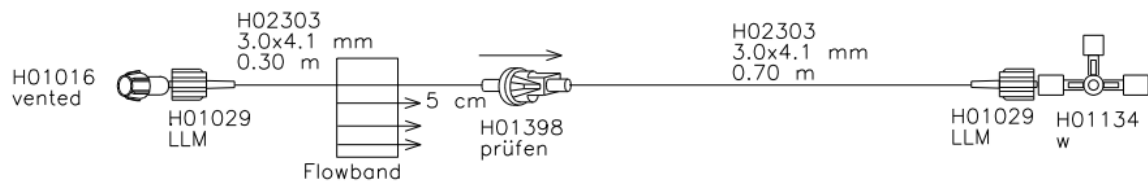
gasfilter:	Pentair DDF4700M02Y-HM
tubing; length:	PVC 1/4" x 1/16" green; 1.00 m / 0.30 m
packaging:	sterile, single
packaging unit:	10 pcs

P3507 – PURGE LINE**Specifications:**

tubing; length:	PVC 3,0 x 4,1mm RB3/80 NDG; 0.30m / 0.70m
opening left:	LuerLock Male
opening right:	4-way stopcock
packaging:	sterile, single
packaging unit:	10 pcs

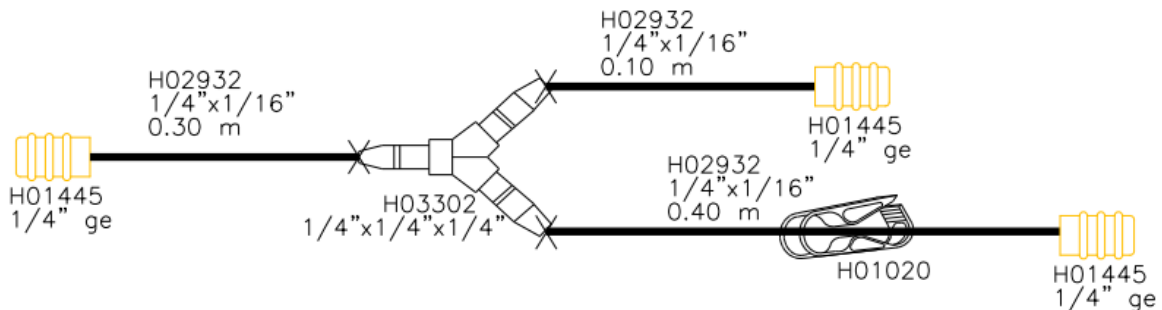
P3508 – RECIRCULATION LINE**Specifications:**

tubing; length:	PVC 1/4" x 1/16"; 0.30 m / 0.10 m / 0.40 m
packaging:	sterile, single
packaging unit:	10 pcs

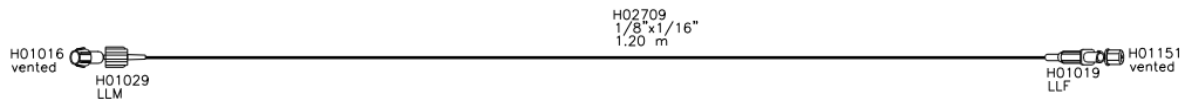
**P3509 – EXTENSION LINE MLL-FLL 1.20 M****Specifications:**

tubing; length:	PVC-SCHL. 1/8" x 1/16" RB6/70 NDG; 1.20 m
opening left:	LuerLock Male
opening right:	LuerLock Female
packaging:	sterile, single
packaging unit:	10 pcs

P3510 – PRESSURE LINE**Specifications:**

tubing; length:	PVC-SCHL. 3.5 x 5.5 mm RB3/80 NDG; 0.15 m / 1.15 m
transducer:	GVS TP010ARA0000AA00
opening left:	LuerLock Female
opening right:	4-way stopcock
packaging:	sterile, single
packaging unit:	15 pcs

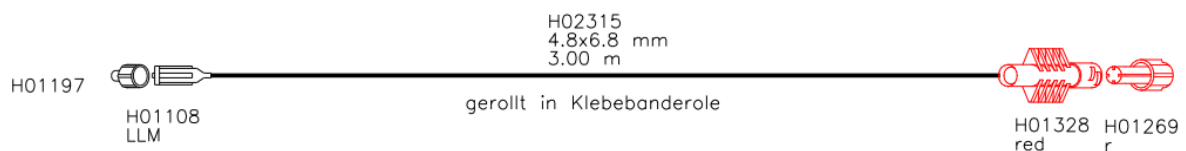
P3511 – CARDIOPLEGIA TABLE LINE**Specifications:**

tubing; length:	PVC-SCHL. 4.8 x 6.8 mm RB3; 3.00 m
opening left:	LuerLock Male
opening right:	quick connector 1/4" female
packaging:	sterile, single
packaging unit:	10 pcs

**P3512 – DRUCKLINIE 60 CM LL-M/LL-W****Specifications:**

tubing; length:	PVC-SCHL. 1.5 x 3.0 mm; 0.60 m
opening left:	LuerLock Male
opening right:	LuerLock Female
packaging:	sterile, single
packaging unit:	15 pcs

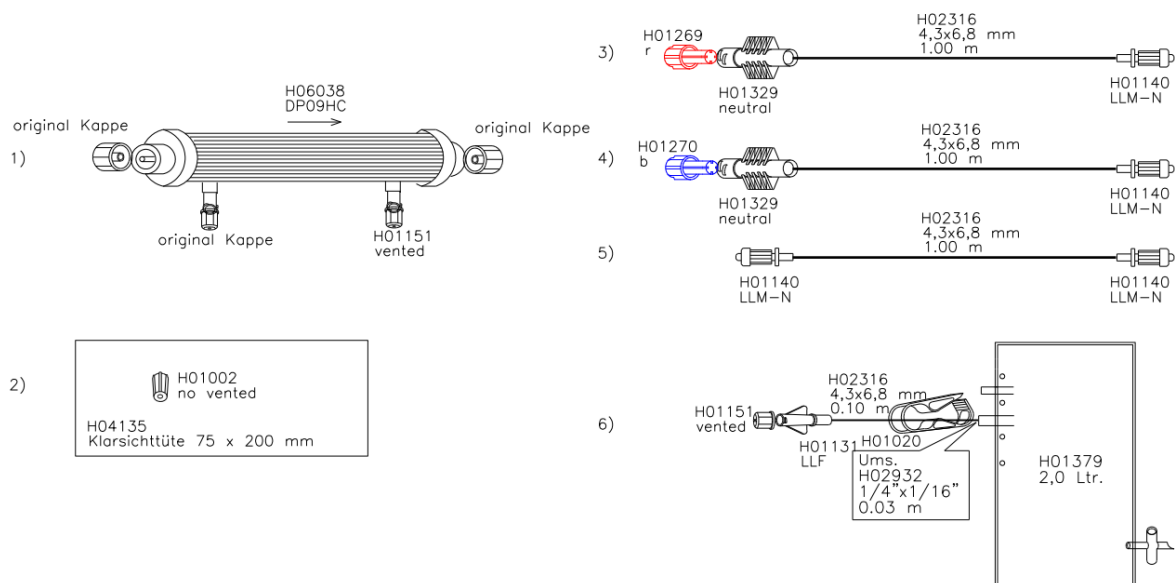
P3513 – HAEMOCONCENTRATOR SET DP09HC**Specifications:**

haemoconcentrator:	DP09HC (Medica)
packaging:	sterile, single
packaging unit:	10 pcs



P3514 – HAEMOCONCENTRATOR SET DP03HC

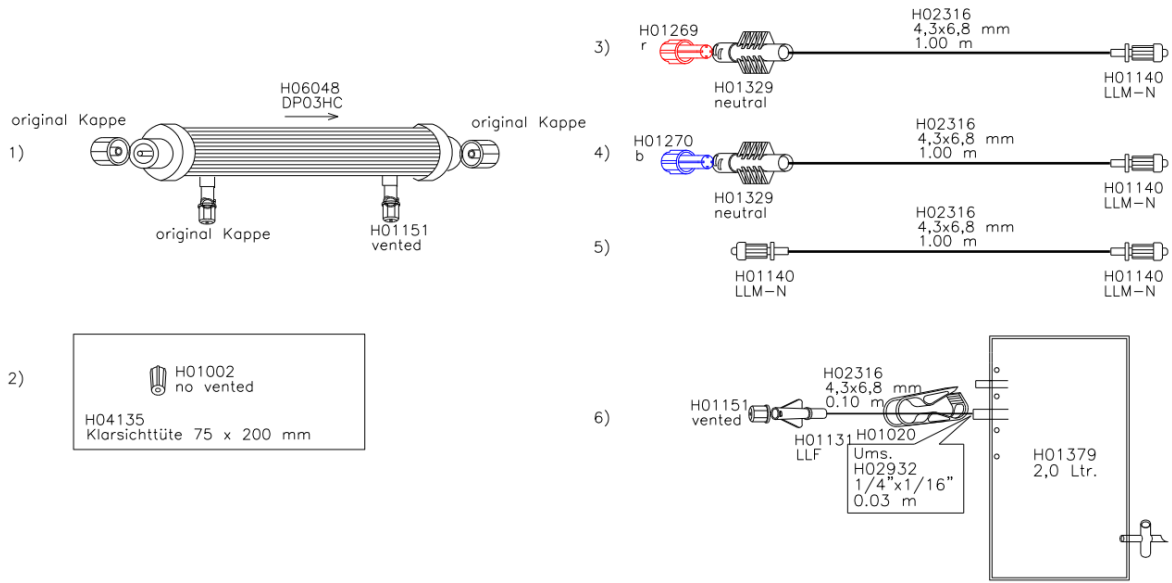

Specifications:

haemoconcentrator:	DP03HC (Medica)
packaging:	sterile, single
packaging unit:	10 pcs

P3515 – Tubing Set 1/4" with Moisture Trap

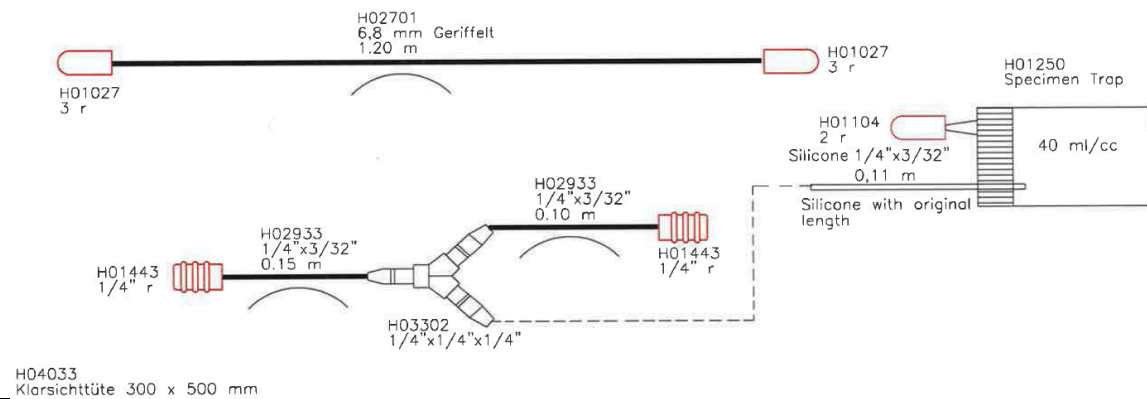

Specifications:

moisture trap	40 ml (not connected)
packaging:	sterile, single
packaging unit:	30 pcs

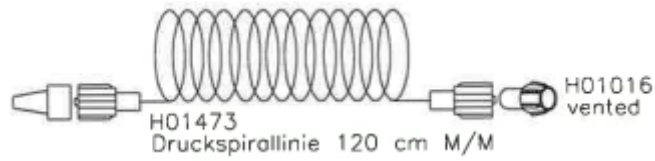
P9060 – PRESSURE LINE 120 CM LL-M/LL-M

Specifications:

tubing; length:	PVC-SCHL. 1.5 x 3.0 mm; 1.20 m
opening left:	LuerLock Male
opening right:	LuerLock Male
packaging:	sterile, single
packaging unit:	10 pcs